

TOOLS



TWEEZERS

XHT-434 XCE  Sharp point

XHT-412 XCE  Cross lock

XHT-612 XCE  Cross lock

XHT-678 XCE  Curved

XHT-700 XCE  Straight

XHT-600 XCE  Round point

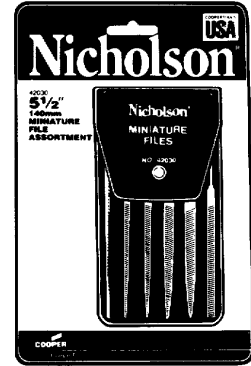

42030 NIC

- ▮ Equaling File
- Round File
- ◐ Half Round File
- Square File
- ▮ Flat File
- ◀ Three Square

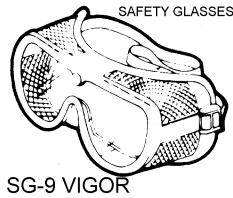

Snap-Ring Plier Set, Combination Internal & External — Set comes with 180°, 90°, & 45° convertible tips. Jaws easily exchanged for internal or external. **100-022 ECL**

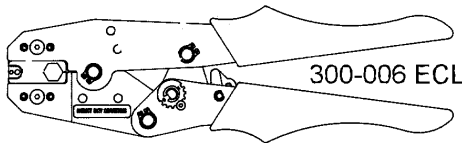

TYPE "N" CONNECTOR CRIMPING TOOL — A full cycle ratchet tool for N-series connectors to fit RG8, 11 (ethernet thickwire), 213, 216 coax. **300-006 ECL**

KINGS COAX CONNECTOR CRIMPING FRAME — Kings **KTH-1000** ratcheting frame has interchangeable dies: **KTH-2001** (RG58), **KTH-2012** (Belden 8281). Frame comes packaged in blue plastic case with room for dies.



CAN'T FIND IT? Give Ack a call. We stock tons not shown in this catalog.





BNC, TNC & N CRIMPING TOOLS (Sargent Tools — American Made for 100 Years!)				
RG TYPE	TOOL	CENTER PIN	OUTER SLEEVE	FEATURES
58, 59, 174 Belden 8281	1056CT SAR	.042 SQ .068 HEX	0.10 .178 .213 .255	THRIFT — Non-ratchet, inexpensive for the occasional user.
59 Belden 8281	2164CCT SAR	.068 HEX	.255 .324	Fine blanked, high carbon steel. Made for 50,000 cycles. Pistol style.
58, 59, 174	4156CCT SAR	.042 SQ .068 HEX	0.10 .178 .213 .255	
8 9913 BEL	300-006 ECL	0.1	0.429	Inexpensive ratcheted tool for "N" type connectors. Taiwan.

NOTE: Ack also stocks tools by Amphenol, Kings, Xcelite, Ideal & Paladin (inquire)

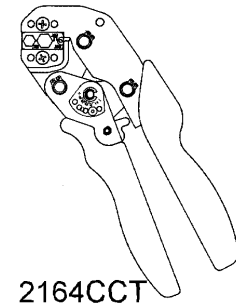

2164CCT

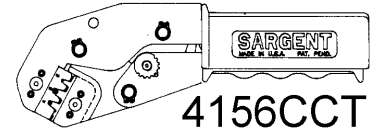

4156CCT

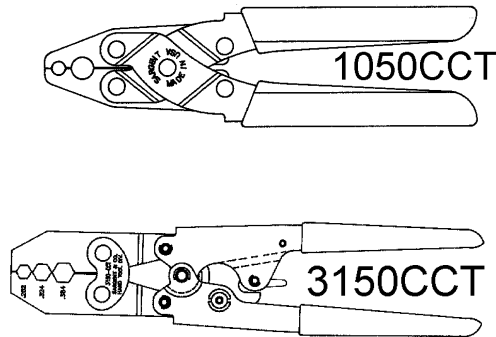

1050CCT

3150CCT

"F" CRIMPING TOOLS			
RG TYPE	PART #	OUTER SLEEVE	FEATURES
6, 59	1050CCT SAR	.252 .408	THRIFT--inexpensive, unratcheted tool for the occasional user.
6, 59	3150CCT SAR	.262 .324 .384	20 year industry standard. Machined high carbon steel, heat treated.
Quad shield 6	PA1356 PAL	-	Crimp tool for RG59 & Quad shield RG, ratcheted.
6 Quad & 59	1098CT SAR	-	COMPRESSION TYPE "F" Connectors (Snap N Seal)
8, 11, 213, 214	24-7711P AIM	.110 .320 .450	Non-ratcheted, pistol type crimper, heavy, economical.

"D" (RS232) PIN CRIMP TOOLS (open barrel male & female contacts)	
300-005 ECL	Inexpensive tool for the occasional user. 14-28 AWG, open barrel. Taiwan.
2127CT SAR	Fine blanked high carbon steel, rated at 50,000 crimps, 18-30 AWG, open barrel. USA.
PA1631 PAL	Ratcheted Paladin for 18-24 AWG, open barrel. German.
PA1442 PAL	CLOSED BARREL contact crimper, 8-indent, 26-20 AWG. Taiwan.

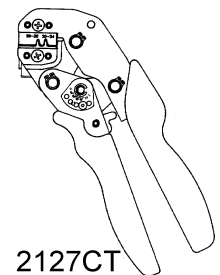

2127CT

TOOLS



**SARGENT
QUALITY
TOOLS**

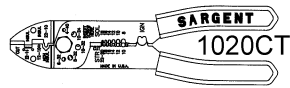
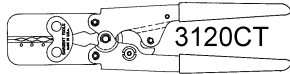

SOLERLESS TERMINAL CRIMPING TOOLS (closed barrel)			
PART #	AWG RED (16-22), BLUE (14-16), YELLOW (10-12)	FOR INSULATED TERMINALS?	FEATURES
3120CT SAR	RED, BLUE, YELLOW	YES	Industry standard for 20 years. machined in high carbon steel, heat treated. USA made.
1020CT SAR	RED, BLUE, YELLOW	YES	THIRFT-Non-ratcheted for the occasional user. Also strips wire, cuts bolts. Made in USA
PA1605 PAL	RED, BLUE	YES	German made quality tool w/built in locator for precise connector alignment.

Paladin Tools

OPEN BARREL CONTACT CRIMPERS (Crimps Molex & Amp Contacts)		
PART #	AWG	FEATURES
300-035 ECL	14-28	Crimps D-Subminiature contacts. Economical, for occasional user. Taiwan.
PA1306 PAL	12-22	For non-insulated open barrel crimp connectors made by AMP, TRW, Cinch, Molex, Landuit, Burndy, Amphenol, Waldom. Ratcheted. Made in ROC
PA1631 PAL	14-24	German made w/built-in locator for precise connector alignment. Ratcheted.

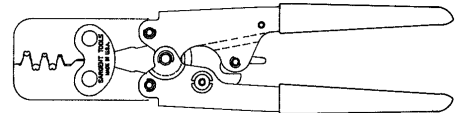

Let Ack  **your parts to you!**

**Check Ack's web site for price & availability:
acksupply.com**

TOOLS

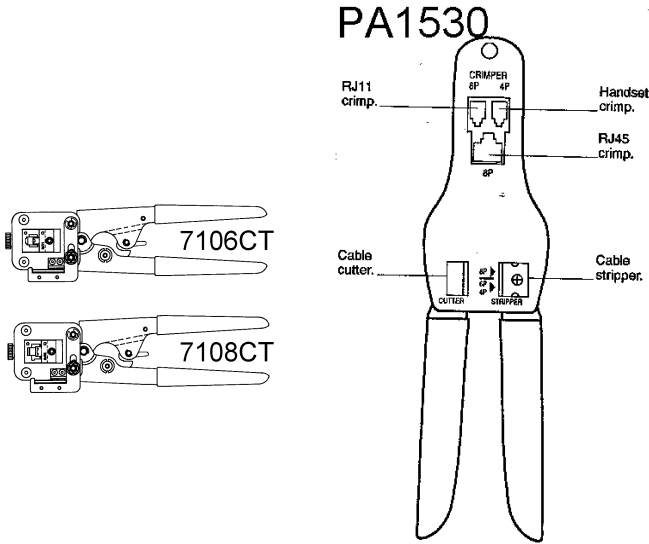

MODULAR PLUG CRIMPING TOOLS* RJ11, 12, 22, 45		
RJ PLUG	FEATURES	TOOL #
RJ11, RJ12	Low cost tool.	WS23 PHI
RJ11, RJ12	Ratcheted, w/cutter & stripper, interchangeable die sets (7100 series), USA.	7106 SAR
RJ11, RJ45	Cuts, strips, & crimps. Taiwan.	300-018 ECL
RJ11, RJ12, RJ45	All-in-One WE (SS), AMP plug crimper. Non-ratcheted. Taiwan.	PA1545 PAL
RJ11, RJ12, RJ22, RJ45	Cuts, strips, & crimps. Non-ratcheted. Nice tool. Will not crimp AMP brand. Taiwan	PA1530R PAL
RJ22 (handset)	Crimps handset (RJ22) plugs.	300-078 ECL
RJ45	Low cost crimper. Taiwan.	12-001 GC
RJ45 & F	Versatile crimper has die for both RJ45 & F connector for RG6 coax! Accepts PA2000 series Paladin dies.	PA8045 PAL
RJ45	Ratcheted, w/cutter & stripper, interchangeable die sets (7100 series), USA.	7508CT SAR

NOTE: RJ11=4 pin, RJ12=6 pin, RJ22=4 pin handset, RJ45=8 pin.
*Unless otherwise noted, tools will not crimp AMP brand modular plugs!

Paladin Tools

ALIGNMENT TOOL KIT, ANTISTATIC—9 different tools for adjusting TVs and other electronic components. **AS-5007 GC**

ALIGNMENT TOOLS, INDIVIDUAL—Ack stocks a good selection of alignment tools (sold singly): Screwdrivers, K-Tran, TV & FM Tuning, Steel Tip Duplex Aligner, Hex, Long Reach, Thin End Steel Tip, 3-in-1 Hex Core, Square, etc. **GIVE US A CALL.**

ALIGNMENT TOOL KIT, RADIO—8 different tools for tuning IF transformers, RF coils, antennas and oscillator coils. **18-530 GC**

BNC REMOVAL TOOL, TROMPETER—Removes those hard to reach BNC connectors! **RT-1L TRO (16") RT-1XL TRO (22")**

CONTACT BURNISHING TOOL—Stainless steel strip microscored to an ultra-fine file surface. Removes oxide on relay & switch contacts. 1/4" width. **9338 GC**

CRIMP TOOL, RIBBON CABLE CONNECTOR—For D-Subminiature, Centronics, Dual In Row, & Card Edge insulation displacement connectors (IDC). **300-011 ECL**

EXTRACTION TOOL, DIP IC—Tweezer style tool. **EX-1 OK**

